



TD3 Depowder Recycling System User Manual

<http://www.cometrue3d.com/>



Safety Information

Read this manual completely before using Depowder Recycling System TD3. Please be sure to follow the instructions and warning information.

- Use the power specification which only indicated on the depowder recycling system TD3 label.
- Never use injured power cord.
- Be careful of the power cord connection. If the plug is injured, please change the power cord or contact with professional staff. If there is any fuse in the plug, be sure to replace it with a fuse of the correct specification and rated power.
- Never repair the depowder recycling system by yourself.
- Keep away from combustible materials.
- Avoid putting the TD3 depowder recycling system in a place where temperature and humidity may change dramatically. Avoid sun exposure, high temperature and chemicals.
- Do not put the machine in a vibrated place and do not drag the machine.
- Before reusing the powder in 3D printer, use the screen to filtrate the powders of TD3. Change powders if they are contaminated heavily, or it may affect the printing quality
- Use goggle and mask to prevent the powder inhaling into body or splashing into eyes.
- If the power cord is damaged, it must be replaced by a special wire or special components from the manufacturer or its service agent. ”
- The machine is not applicable to be used by people (including children) with physical disability, mental disability, or lack of experience and knowledge in using similar products.
- Keep this machine away from children.

- **Warning Symbols**

Mind the symbols below when using ComeTrue TD3:

	Hot Surface: Be careful of the heating area.
	High Voltage : Be careful of the high voltage.

Contents

Safety information	2
I 、 ComeTrue® TD3 operating principle	4
II 、 ComeTrue® TD3 introduction	4
2.1 TD3 APPEARANCE (FRONT).....	4
2.2 TD3 APPEARANCE (BACK).....	4
2.3 TD3 INTERIOR	5
2.4 ACCESSORIES (AIRBRUSH).....	5
III 、 TD3 installation	6
IV 、 TD3 depowder steps	6
V 、 TD3 powder recycling steps	7
VI 、 TD3 cleaning and maintenance	8
VII 、 TD3 powder changing	8
VIII 、 TD3 consumables changing	9
8.1 CHANGING HEAT LAMPS	9
8.2 CHANGING LIGHTING LAMPS.....	10
8.3 CHANGING DUST FILTER	10
8.4CHANGING DUST FILTER BAG	12

I、ComeTrue® TD3 operating principle

ComeTrue® Depowder Recycling System TD3 is a depowder system for 3D printer, it combines airbrush and air compressor to spray the extra powders of the 3D molded product. Then, use heat lamp to dry off the surface of the model.

After depowdering, the extra powders will fall to the bottom of the collection box. The recycling powder should be filtrated by sieve before being reused for the 3D printer.

II、ComeTrue® TD3 introduction

2.1 TD3 appearance (front)

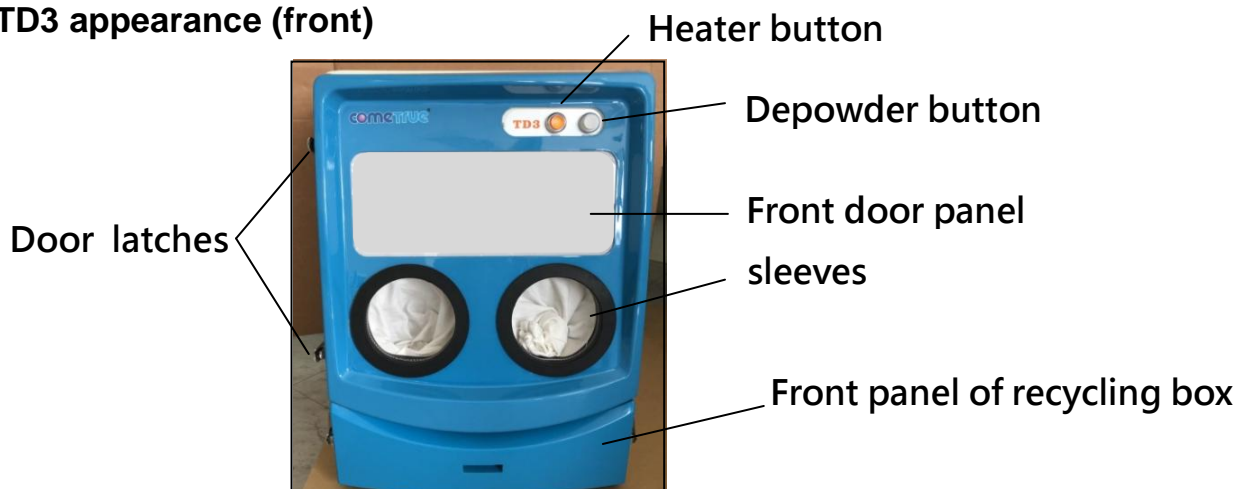

Heater button: power switch of heat lamp

Depowder button: power switch of TD3 (air compressor, blower and lamp)

Front door panel: observation panel of manipulation

Sleeves: hand putting place for manipulation

Front panel of recycling box: dustproof front cover board of powder recycling box

Door latches: latches to seal up the front door and machine

2.2 TD3 appearance (back)

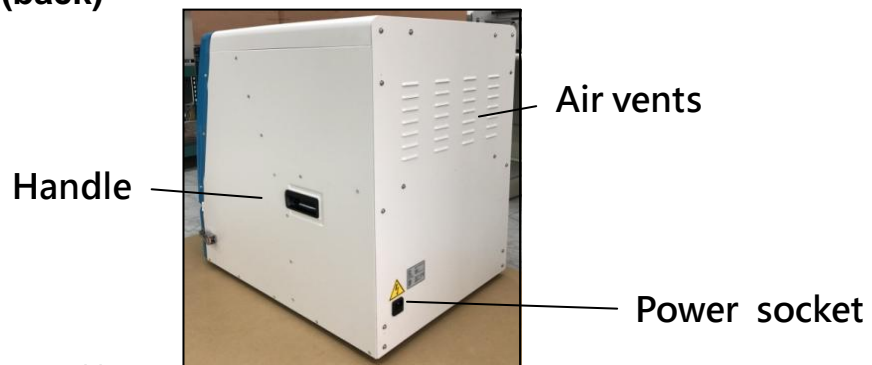

Handle: holder for carrying the machine

Power socket: place to insert power

Air vents: air vents of blower **(caution! do not put it too close to the wall!)**

2.3 TD3 interior

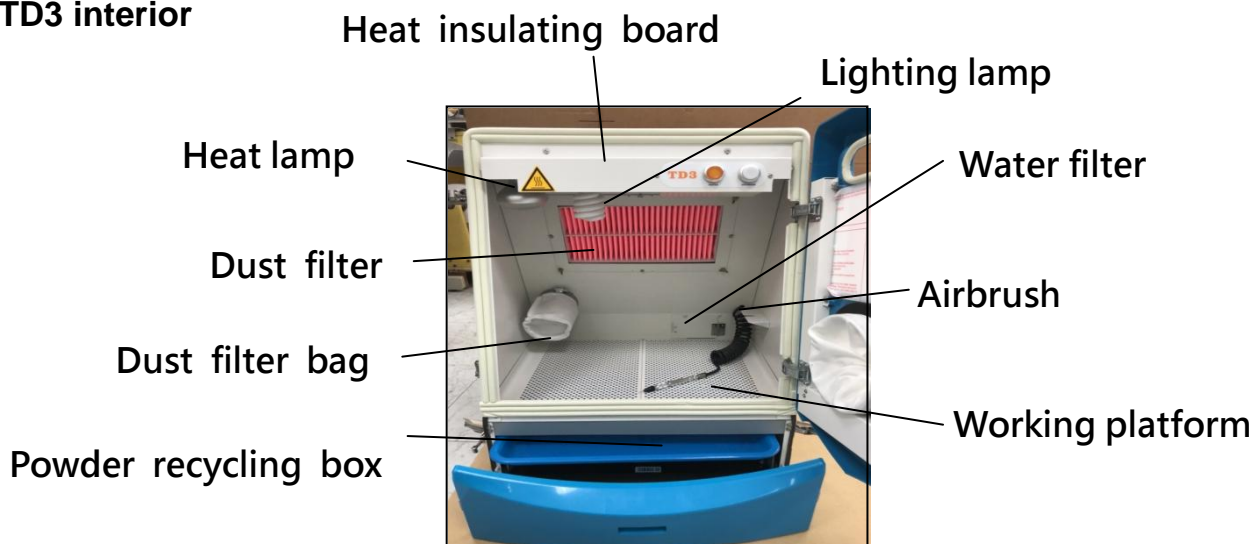

Heat insulating board: insulating board for lamp and infrared ceramic lamp (**caution! High temperature, do not touch it!**)

Heat lamp: heat lamp for heating model (black light 110V/white light 220V)

Lighting lamp: interior light of the machine

Dust filter: blower and rough dust filter

Dust filter bag: blower and fine dust filter bag

Powder recycling box: box for receiving the recycling powder

Airbrush: airbrush to remove powder

Working platform: place for manipulation

Water filter: place for water filter (inside the door).

2.4 Accessories (airbrush)



III 、TD3 installation

Step1. Check the voltage of TD3 first (please refer to the product label on the back of the machine)

Step2. Put the machine on the table, and check if the ventilation runs smoothly (For better operation, it is recommended to place it near the 3D printer)

Step3. Plug in the power

Step4. TD3 depowder is completed.

IV 、TD3 depowder steps

Step1. Please press Heater and Depowder button, the system and the blower will start to heat and operate separately.

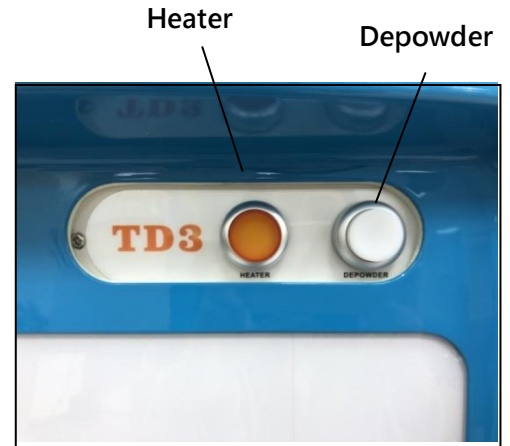

Step2. Open the door latches and front door panel. Then, put the part carefully onto the working platform.

1. Press the door latches forth and remove the latches, then pull it back



2. Open the front door panel

3. Put the part onto the working platform

Step3. Close the door and fasten the latches

Step4. Put your two hands into the sleeves, one hand holds the airbrush, another hand holds the part or just put it onto the working platform.

Put your hands into the sleeves



Step5. Keep the airbrush at an appropriate distance to get rid of the powder and start to depowder.

Step6. After the depowdering process, put the part onto the working platform and take out your hands.

Step7. Open the door latches and the front door panel, then take out the part.

Step8. Use the brush to clean the working platform and the interior walls of TD3 depowder.

V、 TD3 powder recycling steps

Step1. Use the brush to clean powders which onto the working platform and interior walls of TD3 to let it fall to the bottom of the collection box.



! Attention: do not brush the powder of filter and filter bag to the collection box, or the fibers in the filter and filter bag will contaminate the powders !

Step2. Open the powder recycling box.



Step3. Pour the powders which in the recycling box to the screen to Filtrate large powders.

! Attention: do not use powders without filtration, different particle sizes will affect the forming quality and scratch the nozzle. !

NOTE : The density of the screen should be based on the use of powder to determine the thickness. The screened powder can be reused in the ComeTrue® TD3 powder printer.

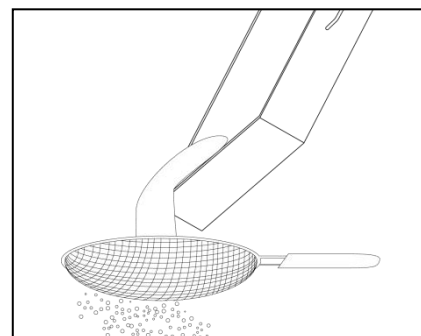

Step4. The powder can be reused after filtration.

It is recommended to clean and maintain the ComeTrue® TD3 after using it to prevent the powders from leaving in the machine. Causing deterioration or moisture then affect the quality of the powder.

VI、TD3 cleaning and maintenance

Step1. After using it, please press the Heater and Depowder button to switch off depowder and heating features. Then, wait until the temperature of heat lamp and lighting lamp cool down, then start to clean.

Attention! The heat lamp and lighting lamp could be in high temperature after heating, touching would be dangerous!



Step2. After the heat lamp cools down, please use the brush to clean up filter and filter bag to keep away from moisture then affect the exhaust filter .

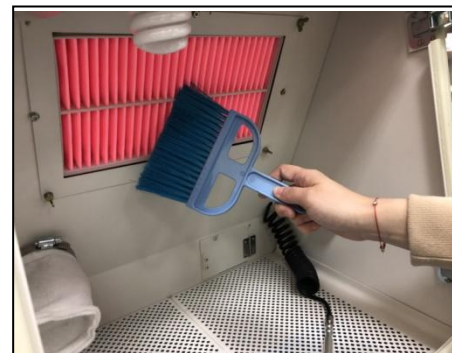

Step3. Use dry towel or vacuum cleaner to clean up powders in TD3 interior walls, working platform and dust in the gap.

Attention! Do not use wet towel or water for cleaning, powders could be harden when contact with water, then causing stuck in machine!

***Step4.** Please remove the dust filter bag and pour away the waste depowder regularly according to the using frequency. Please refer to the 8.4 changing dust filter bag for removing method.

Step5. Press the draining valve on the bottom of the water filter, then use dry towel to wipe extra water.

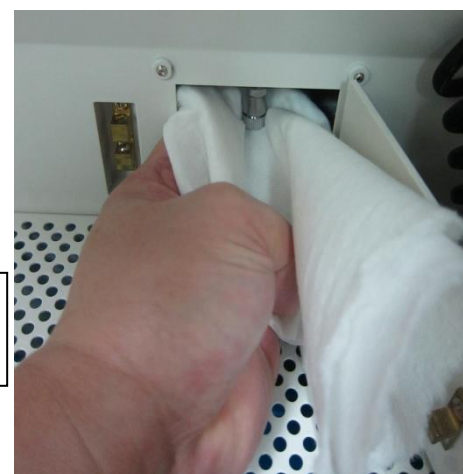
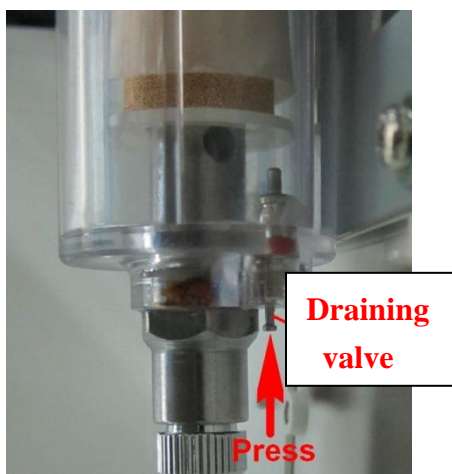

VII 、 TD3 powder changing

Before changing to other depowder, the old powder which has already in TD3 should be cleaned, otherwise the mixing of different kinds of powder can not be reused. For the cleaning method, Please refer to the following steps.

Step1. Use the brush to clean the surface of filter bag softly to ensure the ventilation filter function.



NOTE : To ensure that the powder is not contaminated, it is recommended to change the dust filter directly to ensure that the recycle powder does not mix with the old powder. For the replacement procedure, please refer to 8.3 Dust Filter Replacement.

Step2. Brush the powders which are in the interior walls and working platform to let it fall to the bottom of the collection box, then use the vacuum cleaner to clean the fine powders.

Step3. Open and take out the powder recycling box, pour the impure powders away and clean up the box.



! Attention : if the old powder has been placed in the recycle box for a long time, it may become damp and you can not no longer to use it on the 3D printer anymore !

Step4. Put the powder back to recycling box and close the front door.

VIII 、 TD3 consumables changing

8.1 Changing heat lamp

When pressing Heater button, the heat lamp is not working, but other functions are working normally. It is probably that the heat lamp should be changed. The changing steps are as follows:

Step1. Please switch off the power of machine and remove the power cord, then wait until the temperature of lighting lamp and heat lamp cool down.

Attention! The heat lamp and lighting lamp could be in high temperature after heating, touching would be dangerous!

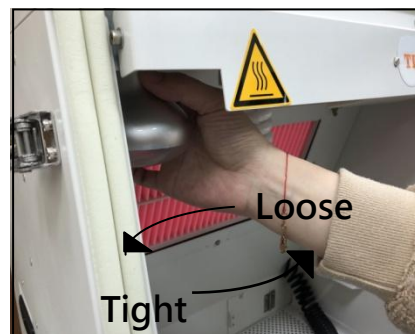

Step2. Open the door latches and the front door panel. Turn down the lamp in clockwise direction. After changing, tighten the lamp in counterclockwise direction.

Step3. Plug the power and press Heater and Depowder button, the process is finished if the lamp is working. If not, please contact with professional staff.

8.2 Changing lighting lamp

When pressing Depowder button, the lighting lamp is not working, but other functions are working normally. It is probably that the lighting lamp should be changed. The changing steps are as follows:

Step1. Please switch off the power of machine and remove the power cord, then wait until the temperature of lighting lamp and heat lamp cool down.

Attention! The heat lamp and lighting lamp could be in high temperature after heating, touching would be dangerous!

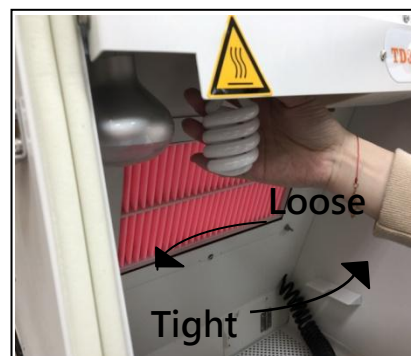

Step2. Open the door latches and the front door panel. Turn down the lamp in clockwise direction. After changing, tighten the lighting lamp in counterclockwise direction.

Step3. Plug the power and press Depowder button, the process is finished if the lamp is working. If not, please contact with professional staff.

8.3 Changing dust filter

After using for long period, the efficacy of filter will decrease. If the cleaning and maintenance of chapter 7 does not improve the efficiency, then the dust filter should be changed. The steps are as follows:

Step1. Please switch off the power of machine and remove the power cord, then wait until the temperature of

lighting lamp and heat lamp cool down.

Attention! The heat lamp and lighting lamp could be in high temperature after heating, touching would be dangerous!

Step2. Open the door latches and the front door panel.

Dismantle the 4 screws on the metal frame of the dust filter in counterclockwise direction.

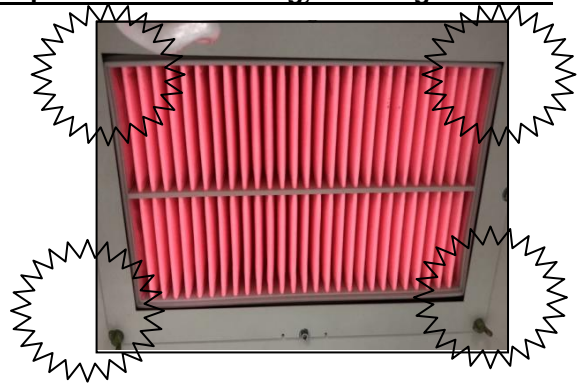

Step3. Take off the metal frame.

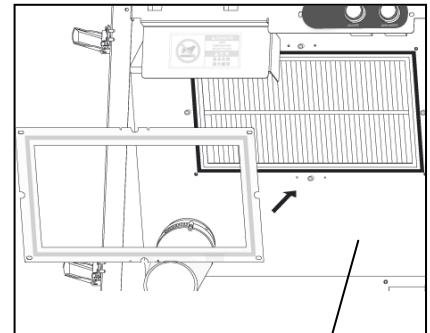

Metal frame

Step4. Take off the filter and change a new one.

Attention! The powder will get harden and block the pores of the filter when touching water. Therefore, the dust filter can not be cleaned for reusing!

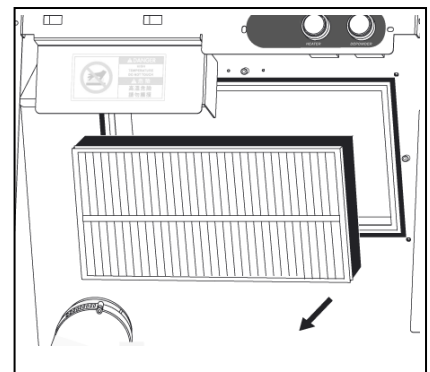

Step5. Put the metal frame dust border align to the machine dust border, latch the 4 screws in clockwise direction. Please make sure the screws are locked tightly, otherwise dusts will go into the machine. If the efficacy of the filter still has not been improved, please contact with professional staff.

Attention! The 4 screws should be tighten with the same tightness (count with loops) if not, the dusts may go into the machine !

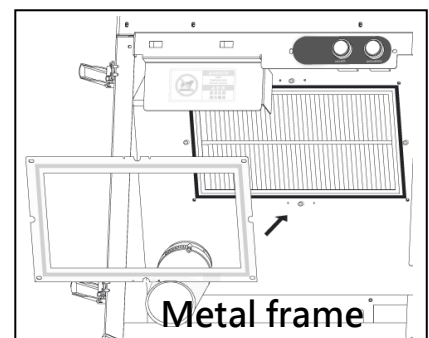

Metal frame

8.4 Changing dust filter bag

After using for long period, the efficacy of filter will decrease. If the cleaning and maintenance of chapter 7 does not improve the efficacy, then the dust filter bag should be changed. The steps are as follows:

Step1. Please switch off the power of machine and remove the power cord, then wait until the temperature of lighting lamp and heat lamp cool down.

Attention! The heat lamp and lighting lamp could be in high temperature after heating, touching would be dangerous!

Step2. Open the door latches and the front door panel. Dismantle Use flathead screwdriver or hex wrench to dismantle the metal screw which is on top of the dust filter bag in counterclockwise direction.



Step3. Remove the filter bag and pour away the powder and the dust

NOTE: If the efficacy of the filter bag still has not been improved, the new filter bag should be changed.



Step4. Remove the metal screw and change a new filter bag, lock it in clockwise direction. If the efficacy of the filter bag still has not been improved, please contact with professional staff.